

CONTESSA

SUPPORTI PROFESSIONALI PER SISTEMI DI PUNTAMENTO
PROFESSIONAL SCOPE MOUNTS



LISTINO PUBBLICO 2021
2021 GENERAL CATALOGUE AND RETAIL PRICE LIST



STANDARD EUROPEAN LINE

CORPO AMOVIBILE PER SLITTE 12mm STANDARD EU



QUICK DETACHABLE MOUNTS

FOR 12mm 60 STANDARD EU RAILS

100% GUARANTEED TO RETURN TO ZERO

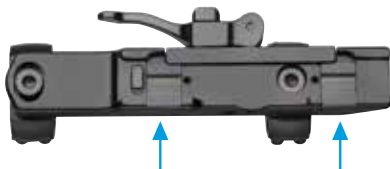

STEEL INSERT SYSTEM CONTESSA®

I punti di chiusura sulla slitta o sull'arma sono in acciaio trilegato temprato ed assicurano massima stabilità e assoluta ripetibilità della taratura tra uno sgancio e l'altro.

The mounting system locks on the firearm by means of hardened steel inserts which guarantee 100% repeatability.



SIMPLE BLACK LR

Code SB01

Per armi basculanti con disposizione degli **anelli arretrati verso il calcio**. QD mount designed for single shot rifles with rear ring 15 mm backwards than standard version.

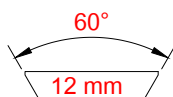
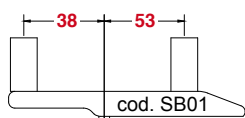

SIMPLE BLACK SBA

Code SB02

Per armi semiautomatiche e bolt action con **leva di chiusura a destra e disposizione standard dell'interasse degli anelli**.

QD mount designed for semiautomatic shotguns and bolt action rifles with locking lever on the right and standard interaxal spacing of the rings.

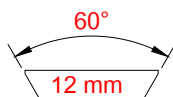
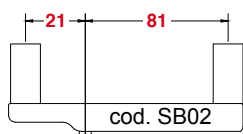

SIMPLE BLACK SBA SX

Code SB02 SX

Per armi semiautomatiche e bolt action **con leva di chiusura a sinistra e disposizione standard dell'interasse degli anelli**.

QD mount designed for semiautomatic shotguns and bolt action rifles with locking lever on the left and standard interaxal spacing of the rings.

SIMPLE BLACK SBA SX

Code SB02 SX-20MOA

Per armi semiautomatiche e bolt action **con leva di chiusura a sinistra e disposizione standard dell'interasse degli anelli**.

QD mount designed for semiautomatic shotguns and bolt action rifles with locking lever on the left and standard interaxal spacing of the rings.

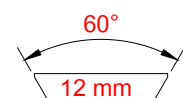
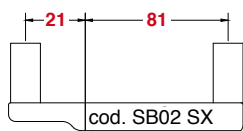



SIMPLE BLACK RD

Code SB03

Corpo con guida Picatinny in acciaio per applicazione **RED-DOT**.
QD mount with top Picatinny rail for RED DOT devices.

SIMPLE BLACK RD SX

Code SB03 SX

Con chiusura Sinistra.
Version with locking lever on the left.

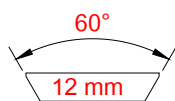

SIMPLE BLACK NV

Code SB04

Corpo con guida Picatinny in acciaio per applicazione **VISORE NOTTURNO**.
QD mount with extra long top Picatinny rail in steel for NIGHT VISION devices.

SIMPLE BLACK NV SX

Code SB04 SX

Con chiusura Sinistra
Version with locking lever on the left

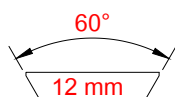

SIMPLE BLACK BRS

Code SB05

Corpo con speciali anelli per applicazione ottica **BURRIS LASER SCOPE**.
Body with special rings for BURRIS LASER SCOPE.

SIMPLE BLACK BRS SX

Code SB05 SX

Con chiusura Sinistra.
Version with locking lever on the left.

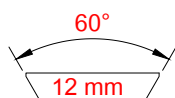

SIMPLE BLACK SWR

Code SBS01

Corpo dedicato esclusivamente alla speciale guida di **SWAROVSKI SR**.
Body dedicated to the SWAROVSKI SR rail system.

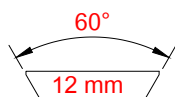

SIMPLE BLACK LDS

Code SBZ01

Corpo a sgancio rapido per speciale guida **ZEISS - LEICA - DOCTER - SCHMIDT & BENDER**.
Body dedicated to ZEISS - LEICA - DOCTER - SCHMIDT & BENDER rail systems.



SERIE ULTRA LOW PER PUNTI ROSSI

ULTRA LOW LINE FOR RED DOT

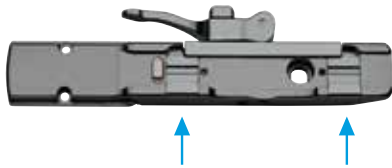

STEEL INSERT SYSTEM CONTESSA®

I punti di chiusura sulla slitta o sull'arma sono in acciaio trilegato temprato ed assicurano massima stabilità e assoluta ripetibilità della taratura tra uno sgancio e l'altro.

The mounting system locks on the firearm by means of hardened steel inserts which guarantee 100% repeatability.

ULTRA LOW DMZ

Code UL01

Corpo dedicato al montaggio di **DOCTER SIGHT II / III, BURRIS FAST FIRE II / III, MEOPTA MEOSIGHT II / III, ZEISS VICTORY COMPACT POINT MOD. PLATTE.**

Quick detachable mount dedicated to DOCTER SIGHT II / III, BURRIS FAST FIRE II / III, MEOPTA MEOSIGHT II / III, ZEISS VICTORY COMPACT POINT MOD. PLATTE.



ULTRA LOW RD

Code UL02

Per montaggio di vari modelli di **RED DOT.**
Quick detachable mounts for RED DOT devices.



ULTRA LOW H1 T1 - H2 T2

Code UL03

Corpo dedicato all'esclusivo montaggio di **AIMPOINT mod. H1 T1- H2 T2.**
Body dedicated to AIMPOINT mod. H1 T1- H2 T2.



ULTRA LOW LEICA TEMPUS

Code UL04

Corpo dedicato al montaggio di **LEICA TEMPUS.**
Body dedicated to LEICA TEMPUS.



NEW ULTRA LOW KITE K1

Code UL05

Corpo dedicato al montaggio di **KITE, KAHLES HELIA RD.**
Body dedicated to KITE, KAHLES HELIA RD.

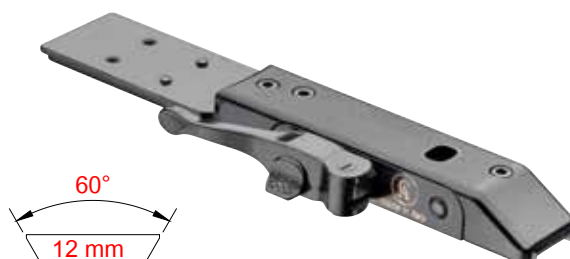



ATTACCHI PER VISORI NOTTURNI

PER GUIDE 12mm 60° STANDARD EU

SPECIFIC MOUNTS FOR NIGHT VISION

FOR 12mm 60 STANDARD EU RAILS

STEEL INSERT SYSTEM CONTESSA®

I punti di chiusura sulla slitta o sull'arma sono in acciaio trilegato temprato ed assicurano massima stabilità e assoluta ripetibilità della taratura tra uno sgancio e l'altro.

The mounting system locks on the firearm by means of hardened steel inserts which guarantee 100% repeatability.

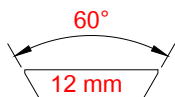

SIMPLE BLACK PLS

Code SB07

Corpo a sgancio rapido per visori **PULSAR e YUKON SIGHTLINE**.
Quick detachable mount dedicated to PULSAR and YUKON SIGHTLINE.

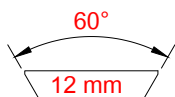

SIMPLE BLACK YP

Code SB08

Corpo a sgancio rapido per visori **YUKON PHOTON**.
Quick detachable mount dedicated to YUKON PHOTON.

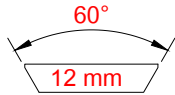

SIMPLE BLACK FOR DDL

Code SB09

Corpo a sgancio rapido per visori **DEDAL**.
Quick detachable mount dedicated to DEDAL.

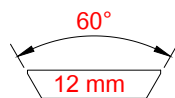

X-MOUNT FOR 12MM DOVETAIL

Code SB12

Corpo a sgancio rapido per visori **ATN X-SIGHT**.
Quick detachable mount dedicated to ATN X-SIGHT.

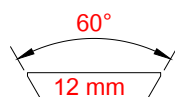

SIMPLE BLACK FOR ATN 4K

Code SB14/A

Code SB14/B

con picatinny per intensificatore
with picatinny for intensifier
senza picatinny per intensificatore
without picatinny for intensifier

Corpo a sgancio rapido per visori **ATN X-SIGHT 4K**.
Quick detachable mount dedicated to ATN X-SIGHT 4K.

SISTEMI DI ATTACCHI FISSI PER GUIDA 12MM 60° STANDARD EU

FIXED BASES AND RINGS FOR 12 MM 60 STANDARD EU RAILS



BFA FIXED MOUNTING SYSTEM

Code FX01

Attacco fisso per ottiche, applicabile su **SLITTE A CODA DI RONDINE 12mm standard EU**.

Possibilità di brandeggio dell'anello posteriore.
Fixed mount for every 12mm DOVETAIL RAIL.
Possibility of swinging the rear ring.



SIMPLE BLACK FX

Code FX02

Corpo monopezzo fisso.

Possibilità alloggiamento anelli di qualsiasi diametro e altezza.
Fixed solid monolithic mount.

Peso complessivo
Total weight: 110,00 g.



LEICA / DOCTER FX

Code LTBFX

Attacco fisso porta **LEICA DOCTER** per **BENELLI ARGO e BAR BROWNING**.

Fixed mount for LEICA DOCTER for BENELLI ARGO and BAR BROWNING.





GUIDE 12mm STANDARD EU ACCIAIO TEMPRATO

12mm STANDARD EU RAILS IN HARDENED STEEL

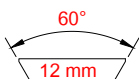

RAILS FOR SEMIAUTOMATIC SHOTGUNS

RS01	BENELLI ARGO
RS02	BENELLI M2
RS03	BROWNING (all model semiauto) WINCHESTER SRX VULCAN
RS04	H&K 770 KIT COMPLETO con TACCA DI MIRA E MIRINO
RS04/A	H&K 770 ONLY RAIL

RS05	H&K SLB2000
RS10	M3 VINCI
RS12	MARLIN 336
RS06	MERKEL SR I
RS07	REMINGTON 7400 - 7500
RS11	VERNEY CARRON



RAILS FOR BOLT ACTION RIFLES

BA26	BENELLI LUPO
BA22	BERGARA BX11
BA01	BROWNING ACERA DUALIS
BA02	BROWNING X-BOLT SHORT
BA03	BROWNING X-BOLT LONG
BA04	BROWNING EUROPEAN
BA05	MANNLICHER SCHOENAUER
BA06	MAUSER ZASTAVA
BA07	REMINGTON 700 SHORT
BA08	REMINGTON 700 LONG
BA21	REMINGTON 770
BA09	REMINGTON 710
BA10	ROESSLER TITAN 6

BA11	SABATTI ROVER 600 SHORT
BA12	SABATTI ROVER 870 LONG
BA13	SAUER 202 STANDARD
BA14	SAUER 202 MAGNUM
BA15	SAUER 200
BA17	TIKKA T3
BA18	WINCHESTER 70 SHORT
BA23	WINCHESTER 70 WSM
BA19	WINCHESTER 70 LONG
BA20	ZOLI ANTONIO AZ 1900
BA24	FRANCHI HORIZON
BA25	HEYM SR 30



RAILS FOR SINGLE SHOT RIFLES

FB14	ARDESA
FB13	BERETTA EXPRESS
FB12	BERGARA BA13
FB01	BATTISTA RIZZINI SOVRAPPOSTO EXPRESS GIUSTAPPOSTO EXPRESS
FB02	BETTINSOLI SOVRAPPOSTO EXPRESS
FB03	CAESAR SOVRAPPOSTO EXPRESS

FB04	EFFEBI TERMINATOR
FB05	FAIR EXPRESS SOVRAPPOSTO
FB06	FAUSTI EXPRESS SOVRAPPOSTO GIUSTAPPOSTO EXPRESS
FB07	INVESTARM ALPINE HUNTER
FB11	ZOLI ANTONIO GIUSTAPPOSTO EXPRESS

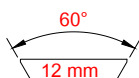

RAIL ADAPTOR SYSTEMS FOR SWALLOW-TAILED BOLT ACTION RIFLES AND SEMIAUTOMATIC SHOTGUNS

SW01	ANSCHUTZ 54 - 64
SW07	BRNO EFFECT
SW01/A	BROWNING FUSION
SW03	CZ 452
SW12	CZ 527
SW02	CZ 550
SW09	MERKEL HELIX - SABATTI SAPHIRE SAKO S20

SW05/A	SAKO 85-75 S
SW05/B	SAKO 85-75 M
SW05/C	SAKO 85-75 L - XL
SW08	SAUER 303
SW06	WINCHESTER SX3

BLS LINE



CORPI AMOVIBILI COMPATIBILI CON ARMI BLASER
QD MOUNTS COMPATIBLE WITH BLASER RIFLES

100% GUARANTEED TO RETURN TO ZERO

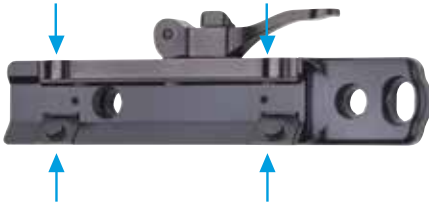

STEEL INSERT SYSTEM CONTESSA®

I punti di chiusura sulla slitta o sull'arma sono in acciaio trilegato temprato ed assicurano massima stabilità e assoluta ripetibilità della taratura tra uno sgancio e l'altro.

The mounting system locks on the firearm by means of hardened steel inserts which guarantee 100% repeatability.



SIMPLE BLACK BLS STD

Code SBB02

Attacco a sgancio rapido compatibile con arma **BLASER con anelli di varie altezze e diametri.**

Quick detachable mount for BLASER rifles with rings of various heights and diameters.



SIMPLE BLACK BLS NV

Code SBB03

Corpo dotato di guida Picatinny allungata di 60 mm, adatta per montare **VISORI NOTTURNI.**

Version with extra long top pic. rail (60 mm extra length) for NIGHT VISION DEVICES.



SIMPLE BLACK BLS LDS

Code SBB04

Corpo dedicato esclusivamente alla guida **ZEISS / LEICA / DOCTER / SCHMIDT & BENDER.**

Body dedicated to rail systems of ZEISS / LEICA / DOCTER / SCHMIDT & BENDER.



SIMPLE BLACK BLS SWR

Code SBB05

Corpo dedicato esclusivamente alla guida **SWAROVSKI.**

Body dedicated to the SWAROVSKI rail system.



APPLICAZIONI SPECIALI COMPATIBILI CON ARMI BLASER

SPECIAL SET UP COMPATIBLE WITH BLASER RIFLES

STEEL INSERT SYSTEM CONTESSA®

I punti di chiusura sulla slitta o sull'arma sono in acciaio trilegato temprato ed assicurano massima stabilità e assoluta ripetibilità della taratura tra uno sgancio e l'altro.

The mounting system locks on the firearm by means of hardened steel inserts which guarantee 100% repeatability.

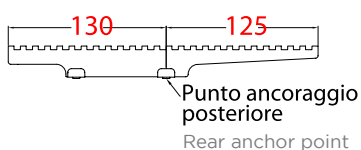

SIMPLE BLACK BLS SPECIAL L

Code SBB07

Attacco a sgancio rapido CON GUIDA PICATINNY INTEGRALE compatibile con **ARMA BLASER**.

One piece QD mount L with SOLID PICATINNY RAIL COMPATIBLE WITH BLASER RIFLES.

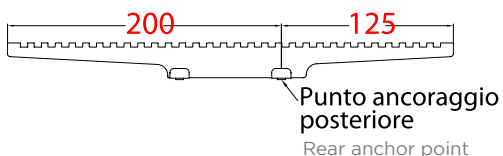

SIMPLE BLACK BLS SPECIAL XL

Code SBB08

Attacco a sgancio rapido CON GUIDA PICATINNY INTEGRALE compatibile con **ARMA BLASER**.

One piece QD mount XL with SOLID PICATINNY RAIL COMPATIBLE WITH BLASER RIFLES.

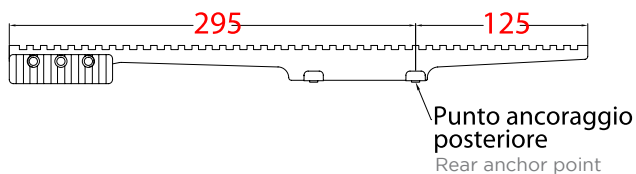

SIMPLE BLACK BLS SPECIAL XXL

Code SBB09

Attacco a sgancio rapido CON GUIDA PICATINNY INTEGRALE compatibile con **ARMA BLASER**.

One piece QD mount XXL with SOLID PICATINNY RAIL COMPATIBLE WITH BLASER RIFLES.

APPLICAZIONI SPECIALI COMPATIBILI CON ARMI BLASER SPECIFICI PER VISORI NOTTURNI



SPECIAL NIGHT VISION SET UP COMPATIBLE WITH BLASER RIFLES

STEEL INSERT SYSTEM CONTESSA®

I punti di chiusura sulla slitta o sull'arma sono in acciaio trilegato temprato ed assicurano massima stabilità e assoluta ripetibilità della taratura tra uno sgancio e l'altro.

The mounting system locks on the firearm by means of hardened steel inserts which guarantee 100% repeatability.



SIMPLE BLACK BLS PLS

Code SBB10

Attacco a sgancio rapido compatibile con arma **BLASER PER VISORI NOTTURNI PULSAR.**

One piece QD mount compatible with BLASER RIFLES AND PULSAR NIGHT VISION DEVICES.



SIMPLE BLACK BLS DDL

Code SBB11

Attacco a sgancio rapido per arma **BLASER PER VISORI NOTTURNI DEDAL.**

One piece QD mount compatible with BLASER RIFLES AND DEDAL NIGHT VISION DEVICES.



SIMPLE BLACK BLS YP

Code SBB13

Attacco a sgancio rapido compatibile con **ARMA BLASER PER YUKON PHOTON.**

QD mount compatible with BLASER RIFLES AND YUKON PHOTON NIGHT VISION DEVICES



X-MOUNT FOR BLS

Code SBB12

Corpo a sgancio rapido per visori **ATN.**

Quick detachable mount dedicated to ATN.



SIMPLE BLACK BLS ATN 4K

Code SBB14/A con picatinny per intensificatore
with picatinny for intensifier

Code SBB14/B senza picatinny per intensificatore
without picatinny for intensifier

Attacco a sgancio rapido compatibile con **ARMA BLASER PER VISORI ATN X-SIGHT 4K.**

QD mount compatible with BLASER DEDICATED TO ATN X-SIGHT 4K.



APPLICAZIONI PER PUNTI ROSSI COMPATIBILI CON ARMI BLASER

SET UP FOR RED-DOT COMPATIBLE WITH BLASER RIFLES

STEEL INSERT SYSTEM CONTESSA®

I punti di chiusura sulla slitta o sull'arma sono in acciaio trilegato temprato ed assicurano massima stabilità e assoluta ripetibilità della taratura tra uno sgancio e l'altro.

The mounting system locks on the firearm by means of hardened steel inserts which guarantee 100% repeatability.

ULTRA LOW BLS

Code ULB01

Corpo **COMPATIBILE CON ARMI BLASER**

dedicato al montaggio di:

Quick detachable mount COMPATIBLE WITH BLASER dedicated to:

DOCTER SIGHT II / III

BURRIS FAST FIRE II / III

MEOPTA MEOSIGHT II / III

ZEISS VICTORY COMPACT POINT MOD. PLATTE.



ULTRA LOW BLS LEICA TEMPUS

Code ULB04

Corpo dedicato all'esclusivo montaggio di **LEICA TEMPUS.**

QD mount for LEICA TEMPUS.



ULTRA LOW BLS H1 T1 - H2 T2

Code ULB03

Corpo dedicato all'esclusivo montaggio di

AIMPOINT mod. H1 T1- H2 T2.

QD mount for AIMPOINT mod. H1 T1- H2 T2.



Blaser
with Aimpoint



PICATINNY RAIL FOR BLS (FIXED MOUNT)

Guida Picatinny in acciaio integrale temprato.
Solid Picatinny rail in hardened steel.

Code FXB01 STANDARD FLAT
 0 MOA

Code FXB02 Estensione
 Extended **0 MOA**

Code FXB03 Estensione
 Extended **20 MOA**





PICATINNY LINE

CORPI AMOVIBILI PER GUIDE PICATINNY QD MOUNTS FOR PICATINNY RAILS

100% GUARANTEED TO RETURN TO ZERO

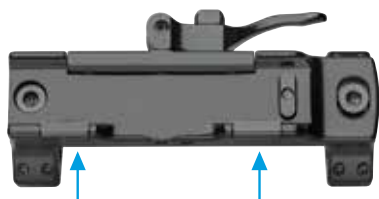

STEEL INSERT SYSTEM CONTESSA®

I punti di chiusura sulla slitta o sull'arma sono in acciaio trilegato temprato ed assicurano massima stabilità e assoluta ripetibilità della taratura tra uno sgancio e l'altro.

The mounting system locks on the firearm by means of hardened steel inserts which guarantee 100% repeatability.



SIMPLE BLACK PICATINNY ONLY BODY

Code SBP00

Solo Corpo.
Body only.

NATO Rail/Grabber
Interface



SIMPLE BLACK PICATINNY STD

Code SBP01

Corpo con anelli di **vari diametri ed altezze.**
Body with rings of different diameters and heights.

NATO Rail/Grabber
Interface



SIMPLE BLACK PICATINNY NV

Code SBP02

Corpo dotato di guida Picatinny allungata di 60 mm, adatta a montare **VISORI NOTTURNI.**

QD mount with extra long top pic. rail (60 mm extra length) for NIGHT VISION DEVICES.

NATO Rail/Grabber
Interface



SIMPLE BLACK PICATINNY RD

Code SBP03

Con guida Picatinny in ergal porta **PUNTO ROSSO.**

QD mount with top pic. rail in Ergal aluminum alloy for RED DOT devices.

NATO Rail/Grabber
Interface



SIMPLE BLACK PICATINNY SWR

Code SBP04

Corpo dedicato esclusivamente alla speciale guida di **SWAROVSKI SR.**

Body dedicated to the special rail system SWAROVSKI SR.

NATO Rail/Grabber
Interface



SIMPLE BLACK PICATINNY LDS

Code SBP05

Corpo dedicato esclusivamente alla guida
ZEISS / LEICA / DOCTER / SCHMIDT & BENDER.
Body dedicated to ZEISS / LEICA / DOCTER /
SCHMIDT & BENDER rail systems.

NATO Rail/Grabber
Interface

ULTRA LOW PICATINNY

ULTRA LOW PICATINNY

Code ULP01

Corpo dedicato al montaggio di:
Quick detachable mount dedicated to:

DOCTER SIGHT II / III
BURRIS FAST FIRE II / III
MEOPTA MEOSIGHT II / III
ZEISS VICTORY COMPACT POINT MOD. PLATTE.

NATO Rail/Grabber
Interface



ULTRA LOW PICATINNY LEICA

Code ULP04

Corpo dedicato al montaggio di **LEICA TEMPUS**
Quick detachable mount for LEICA TEMPUS devices.

NATO Rail/Grabber
Interface



ULTRA LOW PICATINNY RD

Code ULP02

Corpo dedicato al montaggio di vari modelli di **RED DOT.**
Quick detachable mounts for RED DOT devices.

NATO Rail/Grabber
Interface



ULTRA LOW PICATINNY H1-T1 / H2-T2

Code ULP03

Corpo dedicato all'esclusivo montaggio di
AIMPOINT mod. H1 T1- H2 T2.
Body dedicated to AIMPOINT mod. H1 T1- H2 T2.

NATO Rail/Grabber
Interface





STEEL INSERT SYSTEM CONTESSA®

I punti di chiusura sulla slitta o sull'arma sono in acciaio trilegato temprato ed assicurano massima stabilità e assoluta ripetibilità della taratura tra uno sgancio e l'altro.

The mounting system locks on the firearm by means of hardened steel inserts which guarantee 100% repeatability.



SIMPLE BLACK PICATINNY PLS

Code SBP07

Attacco a sgancio rapido per guida Picatinny specifico per **VISORI NOTTURNI PULSAR**.

One piece QD mount for Picatinny rail and PULSAR NIGHT VISION DEVICES.

NATO Rail/Grabber Interface



SIMPLE BLACK PICATINNY YP

Code SBP08

Attacco a sgancio rapido per guida Picatinny specifico per **YUKON PHOTON**.

One piece QD mount for Picatinny rail and YUKON PHOTON night vision devices.

NATO Rail/Grabber Interface



SIMPLE BLACK PICATINNY DDL

Code SBP09

Attacco a sgancio rapido per guida Picatinny specifico per **DEDAL**.

One piece QD mount for Picatinny rail and DEDAL night vision devices.

NATO Rail/Grabber Interface



X-MOUNT FOR PICATINNY RAIL

Code SBP12

Attacco a sgancio rapido per guida Picatinny per visori **ATN**.

One piece QD mount for Picatinny rail ATN devices.

NATO Rail/Grabber Interface



SIMPLE BLACK PICATINNY ATN 4K

Code SBP10/A con picatinny per intensificatore
with picatinny for intensifier

Code SBP10/B senza picatinny per intensificatore
without picatinny for intensifier

Attacco a sgancio rapido per guida Picatinny specifico per **ATN X-SIGHT 4K**.

One piece QD mount for Picatinny rail and ATN X-SIGHT 4K devices.

NATO Rail/Grabber Interface

ATTACCHI FISSI PER SLITTE PICATINNY

FIXED MOUNTS FOR PICATINNY RAILS



FX PICATINNY AND WEAVER
for LEICA TEMPUS / DOCTER SIGHT 2-3
ZEISS VICTORY COMPACT POINT mod. PLATE
BURRIS FAST FIRE II-III / KONUS
Code LTFX

NATO Rail/Grabber
Interface

Attacco fisso in lega leggera porta punti rossi per guide
PICATINNY e WEAVER.
Fixed mount for Red Dot for PICATINNY AND WEAVER rails.



FX PICATINNY AND WEAVER
for AIMPOINT H1-H2 / T1-T2 HOLOSUN
Code AMFX

NATO Rail/Grabber
Interface

Attacco fisso in lega leggera porta punti rossi per guide
PICATINNY e WEAVER.
Fixed mount for Red Dot for PICATINNY AND WEAVER rails.





SLITTE PICATINNY

IN ACCIAIO TEMPRATO – PICATINNY RAILS IN HARDENED STEEL

INCLINATE (0/10/20/30 MOA) PER TIRI A LUNGA DISTANZA

AVAILABLE WITH 0/10/20/30 MOA FOR LONG DISTANCE SHOOTING

PH29	ANSCHUTZ 54 - 64
PH56	BAIKAL
PH07	BENELLI ARGO
PH83	BENELLI LUPO
PH76	BERGARA B14 SHORT
PH77	BERGARA B14 LONG
PH61	BERGARA BA13
PH32	BRNO 98
PH45	BROWNING A-BOLT SHORT / EURO BOLT
PH04	BROWNING A-BOLT LONG / EURO BOLT
PH51	BROWNING A-BOLT 3 SHORT
PH52	BROWNING A-BOLT 3 LONG
PH17	BROWNING BAR
PH53	BROWNING EUROPEAN
PH43	BROWNING X - BOLT SHORT
PH44	BROWNING X - BOLT LONG
PH67	BROWNING X - BOLT EXTRA SHORT
PH28	CZ 452 / 455
PH63	CZ 527
PH49	CZ 550 STANDARD
PH50	CZ 550 ULTRA MAGNUM
PH69	FAIR CF1
PH62	FRANCHI HORIZON
PH78	FRANCHI HORIZON CAL. 223
PH48	HAENEL JAEGER 9
PH54	H&K 940 / 770
PH72	HEYM SR 30
PH10	HOWA Mod. 1500 SHORT
PH11	HOWA Mod. 1500 LONG
PH25	MANNLICHER CLASSIC SHORT
PH26	MANNLICHER CLASSIC MEDIUM
PH27	MANNLICHER CLASSIC LONG
PH79	MARLIN LEVER/336/1895
PH23	MAUSER M12
PH75	MAUSER ZASTAVA M70
PH70	MERKEL HELIX - SABATTI SAPHIRE
PH74	PICATINNY ON PICATINNY
PH02	REMINGTON 700 LONG
PH15	REMINGTON 700 SHORT
PH16	REMINGTON 770

PH80	REMINGTON 7400
PH65	REMINGTON 783 LONG
PH64	REMINGTON 783 SHORT
PH09	ROESSLER TITAN 6
PH08	SABATTI ROVER 600 SHORT
PH20	SABATTI ROVER 870 LONG
PH71	SABATTI SPORTER Cal 22
PH31	SAKO 85 XS
PH12	SAKO 85 S/SM
PH13	SAKO 85 M
PH14	SAKO 85 L/XL
PH36	SAKO A7 XS Cal 223
PH37	SAKO A7 S
PH38	SAKO A7 L
PH82	SAKO S20
PH01	SAKO TRG 42/22
PH24	SAUER 101
PH30	SAUER 200
PH33	SAUER 202 STANDARD
PH34	SAUER 202 MAGNUM
PH60	SAUER 303
PH81	SAUER 404
PH22	SAVAGE 10-11-12 SHORT
PH21	SAVAGE 110-111-112 LONG
PH39	SIG SAUER SSG 3000
PH59	SLB 2000
PH68	TIKKA T1
PH03	TIKKA T3
PH55	VERNEY CARRON
PH35	VOERE 2155
PH42	WEATERBY MARK 5
PH40	WEATERBY VAN GUARD SHORT
PH41	WEATERBY VAN GUARD LONG
PH06	WINCHESTER 70 SHORT
PH18	WINCHESTER 70 WSM
PH19	WINCHESTER 70 LONG
PH46	WINCHESTER 70 EXTRA LONG
PH47	WINCHESTER XPR SHORT
PH57	WINCHESTER XPR LONG
PH05	ZOLI ANTONIO AZ 1900

Su ordinazione si eseguono speciali slitte Picatinny per qualsiasi arma.

On request we manufacture fully customized Picatinny rails for any firearm.

Prezzo da concordare in base alla lavorazione richiesta.

Price to be quoted on an individual basis.

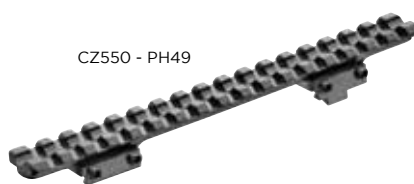

CZ550 - PH49



ANSCHUTZ - PH29



SAKO 85 - PH12



SLITTE PER VISORI NOTTURNI

PICATINNY RAIL WITH REAR EXTENTION FOR NIGHTVISION



Slitte Picatinny **allungate verso il calcio di 60mm** per il montaggio di visori notturni

Picatinny rails extended 60mm towards stock for night vision mounting

PH76-NV	BERGARA B14 SHORT
PH77-NV	BERGARA B14 LONG
PH04-NV	BROWNING A-BOLT
PH52-NV	BROWNING A-BOLT 3 LONG
PH45-NV	BROWNING A-BOLT SHORT
PH51-NV	BROWNING A-BOLT 3 SHORT
PH17-NV	BROWNING BAR
PH43-NV	BROWNING X-BOLT SHORT
PH67-NV	BROWNING X BOLT EXTRA SHORT
PH44-NV	BROWNING X-BOLT LONG
PH27-NV	MANNLICHER CLASSIC LONG
PH23-NV	MAUSER M12
PH70-NV	MERKEL HELYX - SABATTI SAPHIRE
PH74-NV	PICATINNY ON PICATINNY
PH15-NV	REMINGTON 700 SHORT
PH20-NV	SABATTI LONG
PH08-NV	SABATTI SHORT
PH12-NV	SAKO S/SM EXTENDED FOR NIGHT VISION DEVICE
PH13-NV	SAKO M
PH14-NV	SAKO L/XL
PH31-NV	SAKO 85 XS
PH24-NV	SAUER 101
PH33-NV	SAUER 202 STD
PH03-NV	TIKKA T3
PH47-NV	WINCHESTER XPR SHORT
PH57-NV	WINCHESTER XPR LONG
PH05-NV	ZOLI ANTONIO AZ 1900

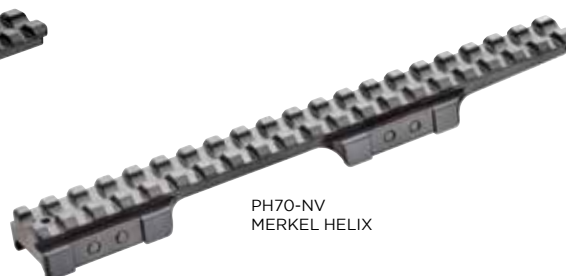
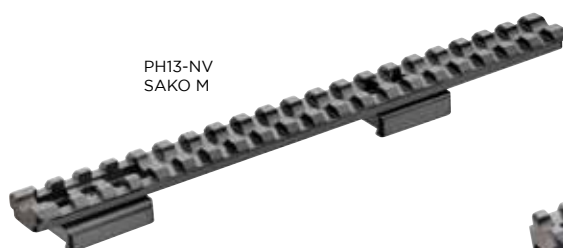



ANELLI PER GUIDE PICATINNY RINGS FOR PICATINNY RAILS

Anelli con **doppio fermo integrale** per guida Picatinny

Picatinny rings with **double integral stop recoil**

LPR01/A	Light Picatinny Rings	ø 1" H 8mm
LPR01/B	Light Picatinny Rings	ø 1" H 12mm
LPR02/A	Light Picatinny Rings	ø 30mm H 8mm
LPR02/B	Light Picatinny Rings	ø 30mm H 12mm
LPR02/C	Light Picatinny Rings	ø 30mm H 19mm
LPR03/A	Light Picatinny Rings	ø 34mm H 8mm
LPR03/B	Light Picatinny Rings	ø 34mm H 12mm
LPR03/C	Light Picatinny Rings	ø 34mm H 19mm
LPR04/A	Light Picatinny Rings	ø 40mm H 8mm
LPR04/B	Light Picatinny Rings	ø 40mm H 14,5mm
LPR05/A	Light Picatinny Rings	ø 36mm H 8mm
LPR05/B	Light Picatinny Rings	ø 36mm H 12mm



DOPPIA VITE DI CHIUSURA
DELLA STAFFA TORX 20

Two locking screws
Torx 20



DOPPIO TRAVERSINO
DI TENUTA SULLA SLITTA

Double stop recoil



ANELLI IN ACCIAIO PER GUIDE PICATINNY O WEAVER

STEEL RINGS FOR PICATINNY AND WEAVER RAILS



Gli anelli possono essere dotati di **fermo largo 5 mm per guide Picatinny** o **fermo largo 4 mm per guide Weaver**

Rings can be fitted with **5mm stop recoil for Picatinny rails** or **4mm stop recoil for Weaver rails**

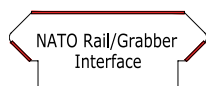

Set of Picatinny rings	ø 1" mm H 8 mm	Code SPP01/A
Set of Picatinny rings	ø 1" mm H 12 mm	Code SPP01/B
Set of Picatinny rings	ø 1" mm H 19 mm	Code SPP01/C
Set of Picatinny rings	ø 1" mm H 26 mm	Code SPP01/D
Set of Picatinny rings	ø 30 mm H 8 mm	Code SPP02/A
Set of Picatinny rings	ø 30 mm H 12 mm	Code SPP02/B
Set of Picatinny rings	ø 30 mm H 19 mm	Code SPP02/C
Set of Picatinny rings	ø 30 mm H 26 mm	Code SPP02/D
Set of Picatinny rings	ø 34 mm H 8 mm	Code SPP03/A
Set of Picatinny rings	ø 34 mm H 12 mm	Code SPP03/B
Set of Picatinny rings	ø 34 mm H 19 mm	Code SPP03/C
Set of Picatinny rings	ø 35 mm H 8 mm	Code SPP04/A
Set of Picatinny rings	ø 35 mm H 12 mm	Code SPP04/B
Set of Picatinny rings	ø 36 mm H 8 mm	Code SPP06/A
Set of Picatinny rings	ø 36 mm H 12 mm	Code SPP06/B
Set of Picatinny rings	ø 40 mm H 8 mm	Code SPP05/A
Set of Picatinny rings	ø 40 mm H 8 mm SR	Code SPP05/A/SR
Set of Picatinny rings	ø 40 mm H 14,5 mm	Code SPP05/B
Set of Picatinny rings	ø 40 mm H 14,5 mm SR	Code SPP05/B/SR
Con chiusura SR / With quick detach SR clamping system		Code SPP.../SR
Con fermo per guida Weaver / with stop recoil for Weaver rail		Code SPP...W



Code SPP01/A/SR

Chiusura SR con leva laterale orientabile (applicabile su tutti i modelli sopra elencati).

Every Contessa SPP ring for Pic rails is now available in the SPP/SR version with quick detach SR clamping system.



ANELLI PER CARABINE CON GUIDA A CODA DI RONDINE 11/12mm - 60°

RINGS FOR RIFLE WITH DOVETAIL RAIL 11/12mm - 60°

Prodotti dedicati a:
Products dedicated to:

ANSCHUTZ
CZ 452/455
WALTER
DIANA
WEIHRACH

SDT01/A	SET PAIR OF STD EU RINGS	ø 1" H 16mm
SDT01/A/SR	SET PAIR OF STD EU RINGS	ø 1" H 16mm SR
SDT01/B	SET PAIR OF STD EU RINGS	ø 1" H 20mm
SDT01/B/SR	SET PAIR OF STD EU RINGS	ø 1" H 20mm SR
SDT01/C	SET PAIR OF STD EU RINGS	ø 1" H 26mm
SDT01/C/SR	SET PAIR OF STD EU RINGS	ø 1" H 26mm SR
SDT02/A	SET PAIR OF STD EU RINGS	ø 30mm H 16mm
SDT02/A/SR	SET PAIR OF STD EU RINGS	ø 30mm H 16mm SR
SDT02/B	SET PAIR OF STD EU RINGS	ø 30mm H 20mm
SDT02/B/SR	SET PAIR OF STD EU RINGS	ø 30mm H 20mm SR
SDT02/C	SET PAIR OF STD EU RINGS	ø 30mm H 26mm
SDT02/C/SR	SET PAIR OF STD EU RINGS	ø 30mm H 26mm SR

Chiusura SR

con apposita vite zigrinata per chiusura rapida senza chiave (applicabile su tutti i modelli sopra elencati).

SR closure

with special knurled screw for quick closing without key (applicable on all the models listed above).



Chiusura Standard

serraggio della staffa con chiave esagonale 4mm (applicabile su tutti i modelli sopra elencati).

Closing Standard

clamp of the bracket with 4mm hexagonal key (applicable on all the models listed above).



ALCUNI ESEMPI DI APPLICAZIONI *EXECUTIONS*



Benelli Argo con Leica



Blaser con Thermion



Beretta Express con Swarovski



TACTICAL LINE

PORTAOTTICA DEDICATI ALL'USO TATTICO SPORTIVO MOUNTS FOR COMPETITIVE AND LONG DISTANCE SHOOTING

STEEL INSERT SYSTEM CONTESSA®

I punti di chiusura sulla slitta o sull'arma sono in acciaio trilegato temprato ed assicurano massima stabilità e assoluta ripetibilità della taratura tra uno sgancio e l'altro.

The mounting system locks on the firearm by means of hardened steel inserts which guarantee 100% repeatability.

NATO Rail/Grabber Interface



SIMPLE BLACK TACTICAL QR

Corpo portaottica monolitico integrale a sgancio rapido per guide Picatinny con **LIVELLA INTEGRATA**.

Disponibili riduzioni in varie misure per gli anelli Ø40mm.

QD solid monolithic mount for Picatinny rails with RINGS AND LEVEL. Ring-diameter reductions available on request for Ø40mm rings.



Code SBT01	Ø 40 mm
Code SBT01/20	Ø 40 mm/20MOA
Code SBT02	Ø 30 mm
Code SBT02/20	Ø 30 mm/20MOA
Code SBT03	Ø 34 mm
Code SBT03/20	Ø 34 mm/20MOA
Code SBT04	Ø 1"
Code SBT04/20	Ø 1"/20MOA

COLORI DISPONIBILI / COLOR AVAILABLE:



100% GUARANTEED TO RETURN TO ZERO

NATO Rail/Grabber Interface



SIMPLE BLACK TACTICAL FX

Corpo portaottica monolitico integrale fisso per guide picatinny con **LIVELLA INTEGRATA**.

Disponibili riduzioni in varie misure per gli anelli Ø40mm.

Fixed solid monolithic mount for Picatinny rails with RINGS AND LEVEL. Ring-diameter reductions available on request for Ø40mm rings.



Code SBTFX01	Ø 40 mm
Code SBTFX01/20	Ø 40 mm/20MOA
Code SBTFX02	Ø 30 mm
Code SBTFX02/20	Ø 30 mm/20MOA
Code SBTFX03	Ø 34 mm
Code SBTFX03/20	Ø 34 mm/20MOA
Code SBTFX04	Ø 1"
Code SBTFX04/20	Ø 1"/20MOA

COLORI DISPONIBILI / COLOR AVAILABLE:



RIDUZIONI ANELLO PER SIMPLE BLACK TACTICAL QR - FX Ø40MM RING REDUCTIONS FOR SIMPLE BLACK TACTICAL QR - FX Ø40MM



Riduzioni con apposite spalline guida, permettono di montare qualsiasi diametro di ottica partendo dal Ø40mm nel **SOLO CORPO TACTICAL QR - FX**.

Perfect-fit ring-diameter reductions allow to accommodate every size scope. Only for TACTICAL QR-FX Ø40mm.

Riduzione / reduction Ø 1"	Code RR01
Riduzione / reduction Ø 30mm	Code RR02
Riduzione / reduction Ø 34mm	Code RR03
Riduzione / reduction Ø 35mm	Code RR04
Riduzione / reduction Ø 36mm	Code RR05

SIMPLE BLACK TACTICAL QR - CANTILEVER



COLORI DISPONIBILI / COLOR AVAILABLE:

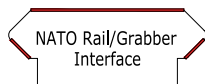

NEW

Corpo portaottica monolitico integrale a sgancio rapido per guide Picatinny con **LIVELLA INTEGRATA**, prolungato in avanti, adatto ad **armi tattiche**.

QD solid monolithic Cantilever mount for Picatinny rails with RINGS AND LEVEL. For tactical firearms.

SBT02 FW \varnothing 30 mm
SBT03 FW \varnothing 34 mm



TACTICAL RINGS HP



Anelli dedicati ad **ARMI TATTICHE** e da competizione, progettati per garantire la massima performance.

High performance rings designed and engineered for competition and TACTICAL SHOOTING.

\varnothing 30mm - H 10mm Code STR02/A
 \varnothing 34mm - H 10mm Code STR03/A

HIGH PERFORMANCE GUARANTEED

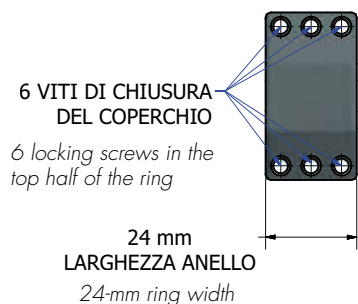

6 VITI DI CHIUSURA DEL COPERCHIO
6 locking screws in the top half of the ring

24 mm
LARGHEZZA ANELLO
24-mm ring width

DOPPIO DADO DI CHIUSURA DELLA STAFFA
Two locking nuts

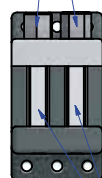

DOPPIO TRAVERSINO IN ACCIAIO PER GUIDE PICATINNY
Double stop recoil

LIVELLA PER PLANARITÀ ARMA
Level for perfect alignment with the gun

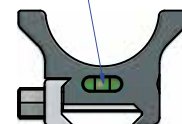

ADATTATORE PER COPERCHIO TACTICAL LINE TACTICAL RING ACCESSORY ADAPTER



Mini Guida Picatinny Code ATL01
Mini pic. rail

Docter Sight II / III Code ATL02

Aimpoint H1/H2 Code ATL03



RICAMBI SPARE PARTS

COPPIE DI ANELLI / RING SETS

Code SP01	SET OF RINGS	ø 30 mm H 3 mm
Code SP02	SET OF RINGS	ø 30 mm H 5 mm
Code SP03	SET OF RINGS	ø 30 mm H 7.5 mm
Code SP04	SET OF RINGS	ø 1" H 2.5 mm
Code SP05	SET OF RINGS	ø 1" H 5 mm
Code SP06	SET OF RINGS	ø 1" H 7.5 mm
Code SP10	SET OF RINGS	ø 34 mm H 6.5 mm
Code SP11	SET OF RINGS	ø 34 mm H 8 mm
Code SP12	SET OF RINGS	ø 36 mm H 5 mm
Code SP13	SET OF RINGS	ø 40 mm H 6 mm
Code SP14	SET OF RINGS	ø 40 mm H 8 mm
Code SP15	SET OF RINGS	ø 40 mm H 13 mm
Code SP16	SET OF RINGS	ø 30 mm H 10 mm



SET 2 VITI TENUTA ANELLO SETS OF 2 RING RETAINING

Code SP07



SET 4 VITI PER SLITTE / SET OF 4 RAIL SCREWS

Code SP08/A	6/48 UNS
Code SP08/B	8/4 UN
Code SP08/C	6/48 UNS LONG
Code SP08/D	3,5 MA
Code SP08/E	3,50 MA LONG



SET VITI PER COPERCHI ANELLI SET OF RING SCREWS

Code SP09



PICATINNY LUNGA PER VISORE EXTRA LONG PICATINNY RAIL FOR NIGHT VISION DEVICES

SIMPLE BLACK SB02 - TACTICAL
Code EB01

SIMPLE BLACK BLASER
Code EBB02



SLITTA PICATINNY CORTA PER RED DOT PICATINNY RAIL

SIMPLE BLACK SB02 - TACTICAL
Code PR01

SIMPLE BLACK BLASER
Code EBB03



ANELLI PER BURRIS LASER SCOPE II / III SPECIAL RINGS FOR BURRIS LASER SCOPE II / III

SIMPLE BLACK - BLASER - TACTICAL
Code LS01



I dati riportati nella presente pubblicazione sono soggetti a modifiche senza impegno di preavviso
The data in this catalogue can be changed at any time with no notice

ALCUNI ESEMPI DI APPLICAZIONI SPECIALI

SPECIAL EXECUTIONS



Si effettua l'applicazione su qualsiasi tipo di arma con apposita lavorazione meccanica realizzata nella nostra ditta.
We can create the custom mount you need directly in our company.

Applicazione per giustapposti e sovrapposti
Custom solutions for over and under and side by side shotguns.



Steyr Stutzen



Mauser 66





CONTESSA®

CONTESSA SRL

Via Canossi, 18/e 25060 Marcheno (Brescia) Italy
tel. +39 030 861648 - Fax +39 030 8966661
E-mail: info@portaotticacontessa.it

www.portaotticacontessa.it

Contessa Alessandro GENERAL DIRECTOR
Contessa Andrea EXPORT SALES MANAGER
Vivenzi Giovanni PRODUCT DEVELOPMENT TECHNICIAN
Zorzi Monia COMMERCIAL MANAGER
Rasori Andrea TECHNICAL CONSULTANT ITALY

DEALER STAMP

MR 223
223 Rev